

CURASA AUTO CPAP USER MANUAL

CE
0123

ENGLISH

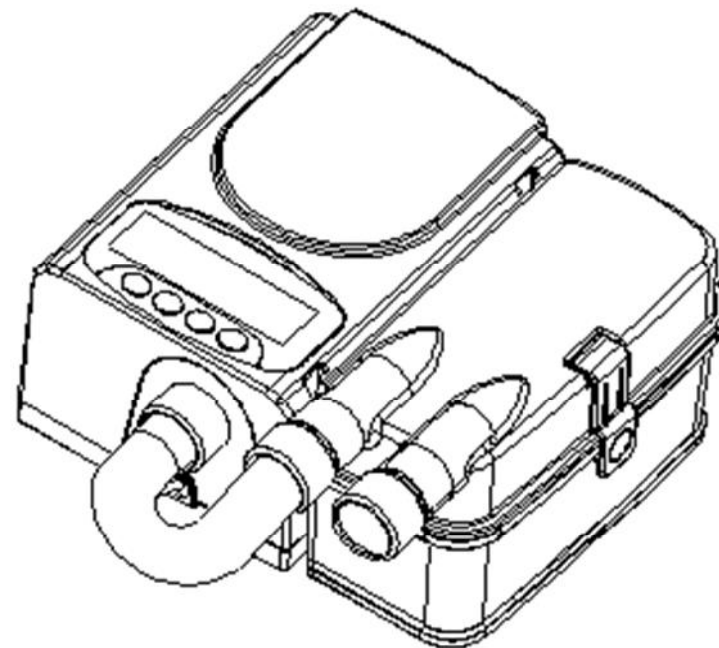











SYMBOL KEY	ERROR! BOOKMARK NOT DEFINED.
CAUTIONS AND WARNINGS	6
CAUTIONS!	6
WARNINGS!	7
LIABILITY	8
INTRODUCTION	9
INTENDED USE	9
CONTRAINDICATIONS	9
DESCRIPTION OF THE DEVICE AND HUMIDIFIER	10
CURASA AUTO CPAP	10
FRONT AND BACK VIEW	11
CONTROL PANEL	12
HUMIDIFIER	13
ACCESSORIES	14
DEVICE AND HUMIDIFIER CONFIGURATION	15
ACCESSORIES AND PARTS	15
CONNECTING THE SYSTEM	15

HUMIDIFIER	16
MASK	16
PARAMETERS, KEYS AND DISPLAY	17
PARAMETERS	17
KEYS	18
DISPLAY CPAP MODE	19
DISPLAY AUTO MODE	20
FUNCTIONS OF THE DEVICE	21
AUTOMATIC MODE	21
MANUAL MODE	21
RAMP FUNCTION	21
ALARMS	22
POWER FAILURE	22
CHECKING THE POWER FAILURE ALARM	22
LEAKAGE	22
CLEANING AND MAINTENANCE	23
CLEANING THE CURASA AUTO CPAP	23
CHANGING THE CURASA AUTO CPAP CLOCK BATTERY	23

CLEANING THE HUMIDIFIER	23
HUMIDIFIER FUSE	23
CHANGING FILTER	24
<u>TROUBLESHOOTING</u>	<u>25</u>
SERVICE	28
<u>SPECIFICATIONS</u>	<u>28</u>
<u>DISPOSAL</u>	<u>29</u>
<u>QUALITY WARRANTY</u>	<u>ERROR! BOOKMARK NOT DEFINED.</u>
<u>ELECTRIC MAGNETIC INFORMATION</u>	<u>30</u>
GUIDANCE AND MANUFACTURERS DECLARATION OF ELECTROMAGNETIC IMMUNITY FOR EQUIPMENT AND SYSTEMS THAT ARE NOT LIFE SUPPORTING	30
RECOMMENDED SEPARATION DISTANCES BETWEEN PORTABLE AND MOBILE RF COMMUNICATIONS EQUIPMENT AND THE FLOTON AUTO CPAP	33
<u>DISCLAIMER OF WARRANTY AND LIMITATION OF CURASA</u>	<u>ERROR! BOOKMARK NOT DEFINED.</u>
<u>CONTACT DETAILS</u>	<u>34</u>

SYMBOL KEY

									
Attention! Consult accompanying documents	Manufacturer	Date of manufacture	Serial number	Type B applied part	Class II Double insulated	The device, accessories and the packaging have to be disposed correctly at the end of the usage. Please follow Local Laws and Ordinances for disposal	DC Power	Standby	CE marked product

CAUTIONS AND WARNINGS

CAUTIONS!

- This device is restricted to sale by or on the order of a physician.
- Do not use the device before the recommended therapeutic pressure is prescribed by a physician.
- The device should be used with the external AC/DC adapter provided by manufacturer. Use of other AC/DC adapters may damage the device or cause fire and electric shock hazards.
- To prevent water entering the breathing circuit connection on the mask, the device must always be positioned below the head.
- Do not use the device at room temperatures above 35°C. If the device is used when temperature is above 35°C then the temperature of the airflow may exceed 41°C, which could cause thermal irritation or injury to the patient's airway.
- Do not place the device near any items (curtains, bedding, couch) or heating devices (air conditioners, radiators, vents) that may disrupt the airflow around the device.
- Before carrying or packing the device you must empty the humidifier of water
- The device should only be used with  marked parts provided or recommended by your authorized dealer.
- Check the alarm function regularly and if the device has not been used for a long time please check the power failure alarm before use. If the Power failure alarm is invalid the device must be left in stand-by mode or left running for at least 12 hours before checking the alarm again to make sure it is functioning normally.

- If the device has recently been placed in a very hot or very cold environment, wait for 2 hours to allow temperature to normalize before switching the device on.
- The device can only be operated at temperatures between 5°C and 35°C.

WARNINGS!

- The device cannot be used whilst mobile.
- This device is for adult use only and not for use by children or persons with certain disabilities who would require supervision in order to use the device safely.
- The device cannot be used for life support.
- Do not use the device in the presence of nitrous oxide or flammable anesthetic mixtures in combination with oxygen or air.
- In the event that the device noise level becomes higher than normal, the devices output of air becomes too hot, the device has an abnormal smell or if any part of the device becomes broken, stop using it immediately contact an authorized dealer.
- The device can only be switched off completely when the power supply is disconnected from the wall socket.
- Make sure the exhalation opening in the mask or swivel is open so that the exhaled air containing CO₂ can escape.
- To avoid rebreathing do not wear the mask for more than 3 minutes when the device is not switched on. (Note. At low pressures the airflow may not be sufficient to remove all exhaled gas (CO₂) therefore some rebreathing may occur
- The air inlet of the device should never be covered.
- To avoid electric shock:
 - Do not use the device if the device if the casing or cables are damaged.

- Do not use the device if it has been dropped in water.
- Keep device away from water.
- Before cleaning the device pull the power plug out of the socket.
- This device is for single patient use only and should not be shared with other patients.
- If the patient experiences mucous membrane dryness in the nose and pharynx, frontal sinus trouble, earache, a running nose or skin sensitivity etc. you should consult your physician immediately.
- Operation of the device may be adversely affected by:
 - Electromagnetic fields exceeding the level of 3V/m in the test conditions of EN 60601-1-2
 - The operation of high frequency (diathermy) equipment.
 - Defibrillators, or short wave therapy equipment
 - Radiation (e.g., X-ray, CT)
 - Magnetic fields (e.g., MRI).
 - Do not sterilize the device with high pressured steam

LIABILITY

The manufacturer shall not be held liable for any damages in case of:

- Tampering, modifying, adding expansion features or repair by persons who have not been authorized by the manufacturer.
- Using accessory or spare parts that are not recommended by us, or not officially registered.
- Using the device in a way that was not instructed in the manual.

INTRODUCTION

INTENDED USE

The Curasa AUTO CPAP respiratory sleep apnea breathing therapy device is for use by patients with sleep apnea or hypopnea syndrome to reduce the frequency of sleep apnea, hypopnea and increases nocturnal SaO₂.

It provides a stable continuous positive airway pressure whilst the humidifier provides warm and humid air which helps to avoid nose and airway dryness increasing the comfort for the patient.

The therapeutic pressure is prescribed by a physician according to patient's condition.

CONTRAINDICATIONS

The use of positive airway pressure may be contraindicated if the patient suffers from the following pre existing conditions:

- Pneumothorax
- Pneumomediastinum (Air in mediastinum)
- Cerebrospinal fluid leakage
- Pneumocephalus
- Extremely low blood pressure or shock
- Confusion or coma resulting in the patient not been able to co-operate with or accept the mask
- Excessive secretions in the airway as well as not coughing effectively and weak voluntary breathing.

DESCRIPTION OF THE DEVICE AND HUMIDIFIER

CURASA AUTO CPAP

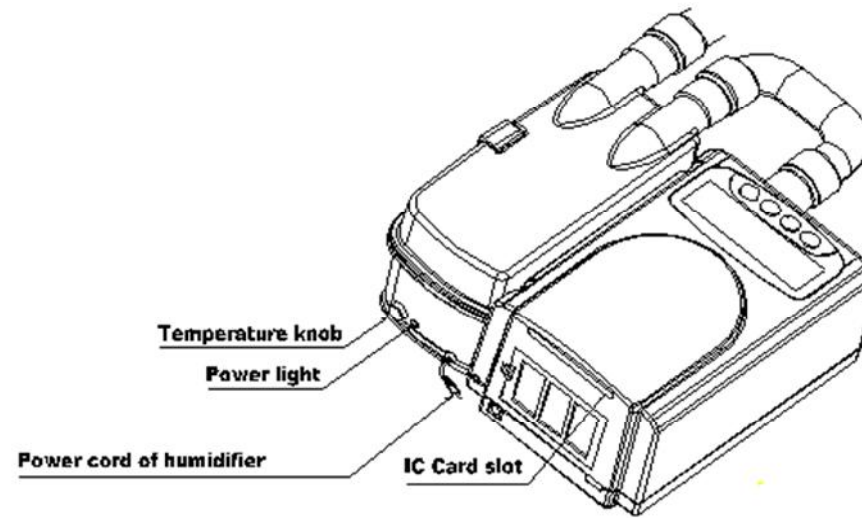
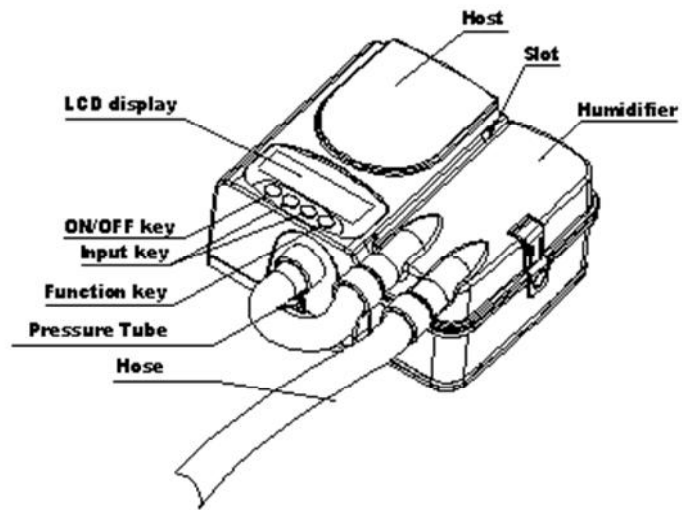

FRONT AND BACK VIEW

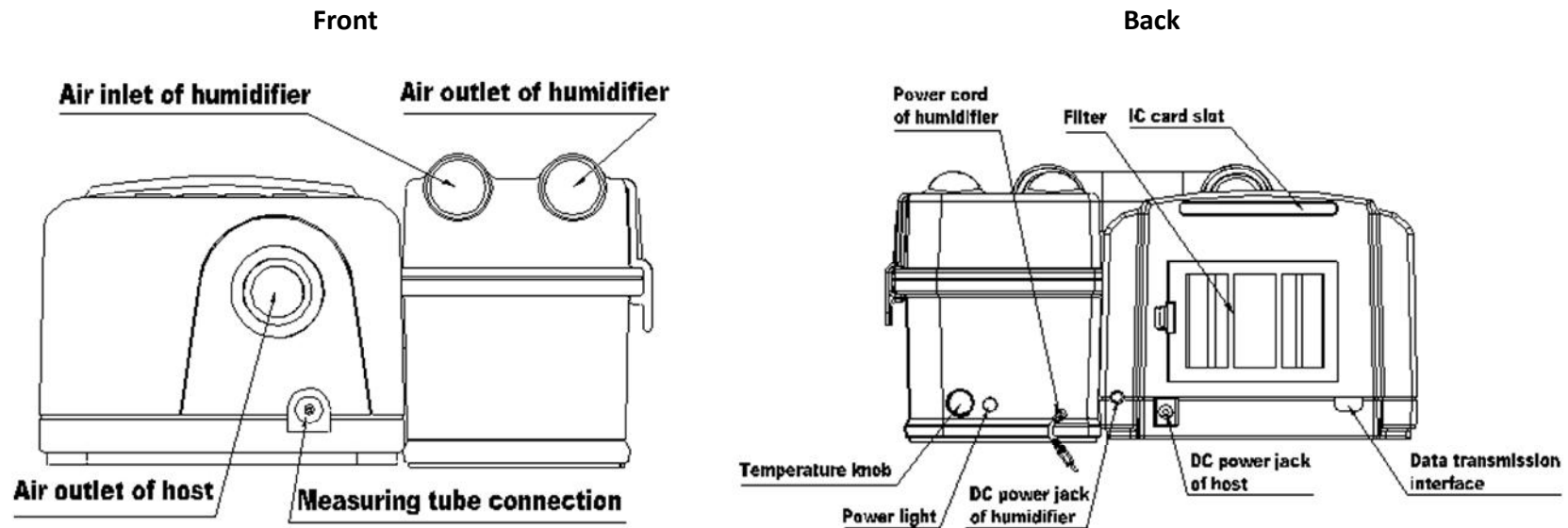

Attention! The data transmission interface is only used during production or service when transmitting data to RS232 or to the USB of a PC.

Equipment connected to the analog or digital interfaces must comply with the respective IEC standards (e.g. IEC 950 for data processing equipment and IEC 60601-1 for medical equipment). All configurations shall comply with the current version of the standard for SYSTEMS IEC 601-1-1. If you are in doubt consult the technical service department or your local representative. RS232 and the USB port are only for technical use.

CONTROL PANEL

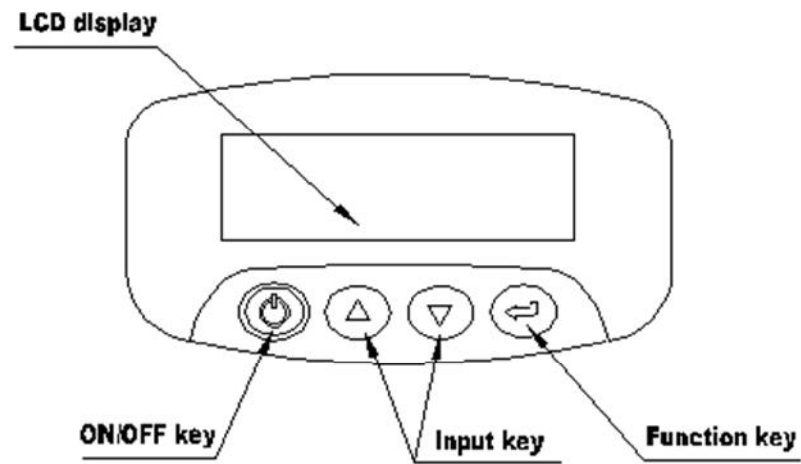

HUMIDIFIER

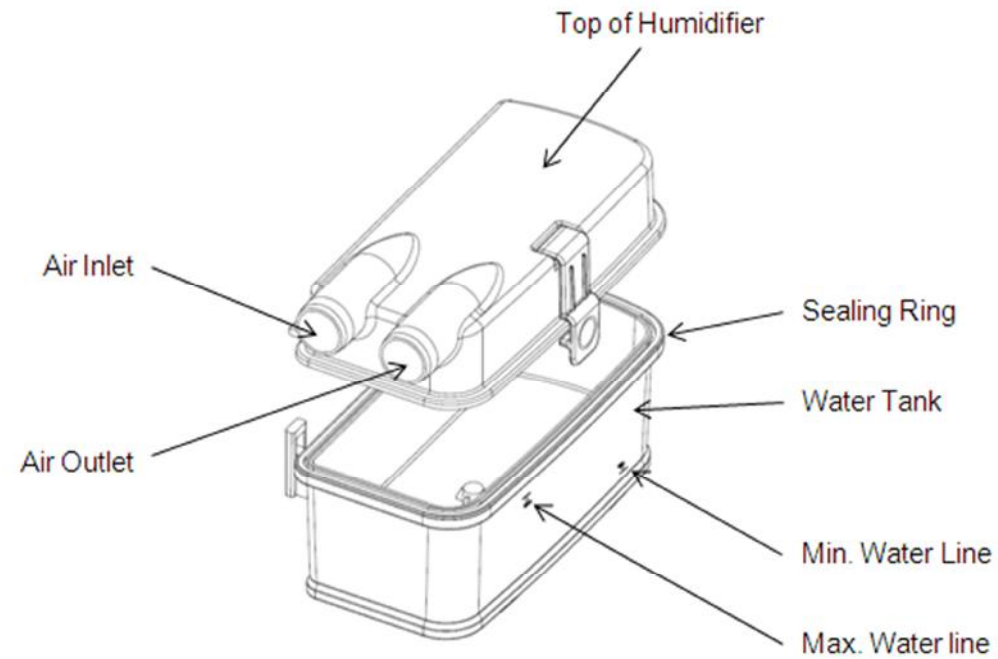

Warning! The humidifiers DC power jack can only be used to connect to the device with the provided power cable for the humidifier. Do not connect it with the other devices.

ACCESSORIES

Power supply cord and power supply adapter

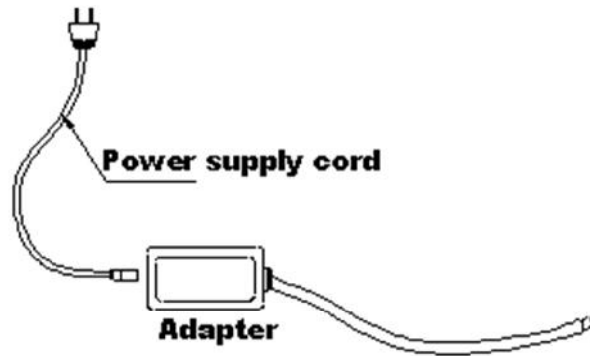

Connecting tube

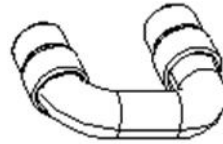

Hose with a pressure tube



WARNING! The device should be used only with the external AC/DC adapter provided by manufacturer. Use of other AC/DC adapters may cause damage to the device and cause fire and electric shock hazards.

DEVICE AND HUMIDIFIER CONFIGURATION

ACCESSORIES AND PARTS

- 1 Curasa AUTO CPAP device (including one fine filter)
- 1 Humidifier
- 1 Power supply adapter (including one power supply cord for AC input)
- 1 Hose with an inserted pressure tube
- 1 Mask (connector diameter 22mm)*
- 1 Headgear (for use with mask)*
- 1 Connecting tube

Note: Items with * can be supplied by the manufacturer or purchased from other vendors that are CE-marked.

CONNECTING THE SYSTEM

- Check whether the device is damaged and if any accessories or parts are missing.
- Put the device on a stable and even surface. Make sure the air inlet in the back of the device is not blocked.
- Connect the power supply adapter with the power supply cord and then connect the DC output of adapter with DC power jack on the back of the device.
- Connect the two ends of the hose to the device's air outlet and mask separately.
- Connect the pressure tube to the pressure port in the device.
- Connect to the power supply. Power supply adapter: AC input voltage range: AC 100-240V (50/60Hz); DC output: 24VDC2.5A Max. When the device is on the power indicator light will illuminate and the display will show the preset parameters.

HUMIDIFIER

- Before the first use of the Curasa AUTO CPAP humidifier please clean it thoroughly.
- When filling the humidifier with water please disconnect it from the device
- Fill the Curasa AUTO CPAP humidifier with purified or distilled water only. The water must be cool, contain no other additions and be below the maximum water line.
- The temperature range of the humidifier can be adjusted according to patient's requirement.
- When humidifier is connected correctly and the device is turned on and is delivering airflow, the humidifier automatically heats and the indicator will light green. When it reaches the set temperature the indicator light will switch off. Use the knob to adjust the heating level.

MASK

For information on use of the mask please refer to separate instructions provided with the mask.

PARAMETERS, KEYS AND DISPLAY

PARAMETERS

Function	Introduction	Range
MODE	Choose between AUTO and CPAP mode.	N/A
MAXP	AUTO Max. pressure	4-20cmH ₂ O(~0.4~2.0kPa) [0.5 cmH ₂ O(0.05kPa) per step]
MINP	AUTO Min. pressure	4-20cmH ₂ O(~0.4~2.0kPa) [0.5 cmH ₂ O(0.05kPa) per step]
PRESS	CPAP Pressure AUTO Pressure: Display or change the current pressure	4-20cmH ₂ O(~0.4~2.0kPa) [0.5 cmH ₂ O(0.05kPa) per step]
RAMP	Ramp time. When using the ramp function the pressure starts at 4cmH ₂ O and rises until the device reaches the set "PRESS"	0-60min increasing pressure 1 step per minute.
AUTOON	Automatic operation mode (ON/OFF)	N/A
OPERATE	Setting the operation time	0-99999hr
THERAPY	Setting the therapy time	0-99999hr
CLEAR THERAPY?	Clear the therapy time	Choose between YES or NO
DD-MM-YYYY	Displays the date	N/A
HH-MM-SS	Displays the time	N/A
PASSWD	Password for changing pressure	4 digits
VERSION	Displays the software version of the device	N/A

KEYS

ON/OFF KEY



 Press the key down gently for about 1-2 seconds to turn on the device.

When the device is turned on the background light of LCD display will be illuminated. It will be turned off if no any action is performed within 5 seconds. When the Power supply is plugged in the device is in stand-by mode. The power indicator will be continuously on when the device is in stand-by mode.

Device On/Off means that motor is On or Off.





Power On/Off means that power supply is On or Off.

INPUT KEYS

  Input keys are used for selecting functions and adjusting the parameters of a given function.

RETURN KEY

 Return key is used for accessing edit mode and confirming changes of parameters.

- To access edit mode to adjust parameters press the  key once so that the editing function field blinks.
- With the input keys   change the value of the selected parameter.
- Press  key again to confirm and move to next parameter automatically.

DISPLAY CPAP MODE

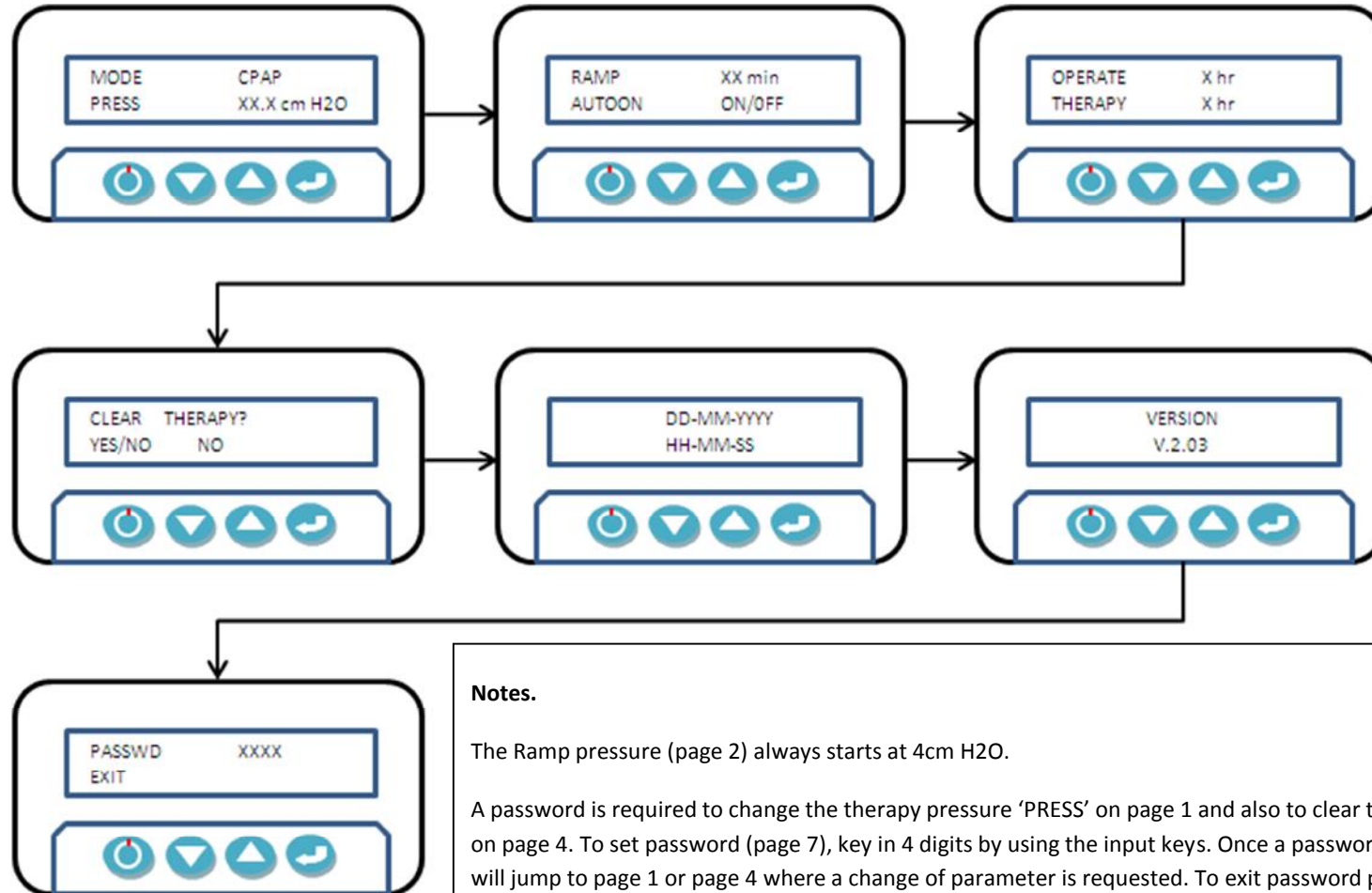

Notes.

The Ramp pressure (page 2) always starts at 4cm H2O.

A password is required to change the therapy pressure 'PRESS' on page 1 and also to clear the Therapy Time on page 4. To set password (page 7), key in 4 digits by using the input keys. Once a password is accepted it will jump to page 1 or page 4 where a change of parameter is requested. To exit password page select EXIT.

DISPLAY AUTO MODE

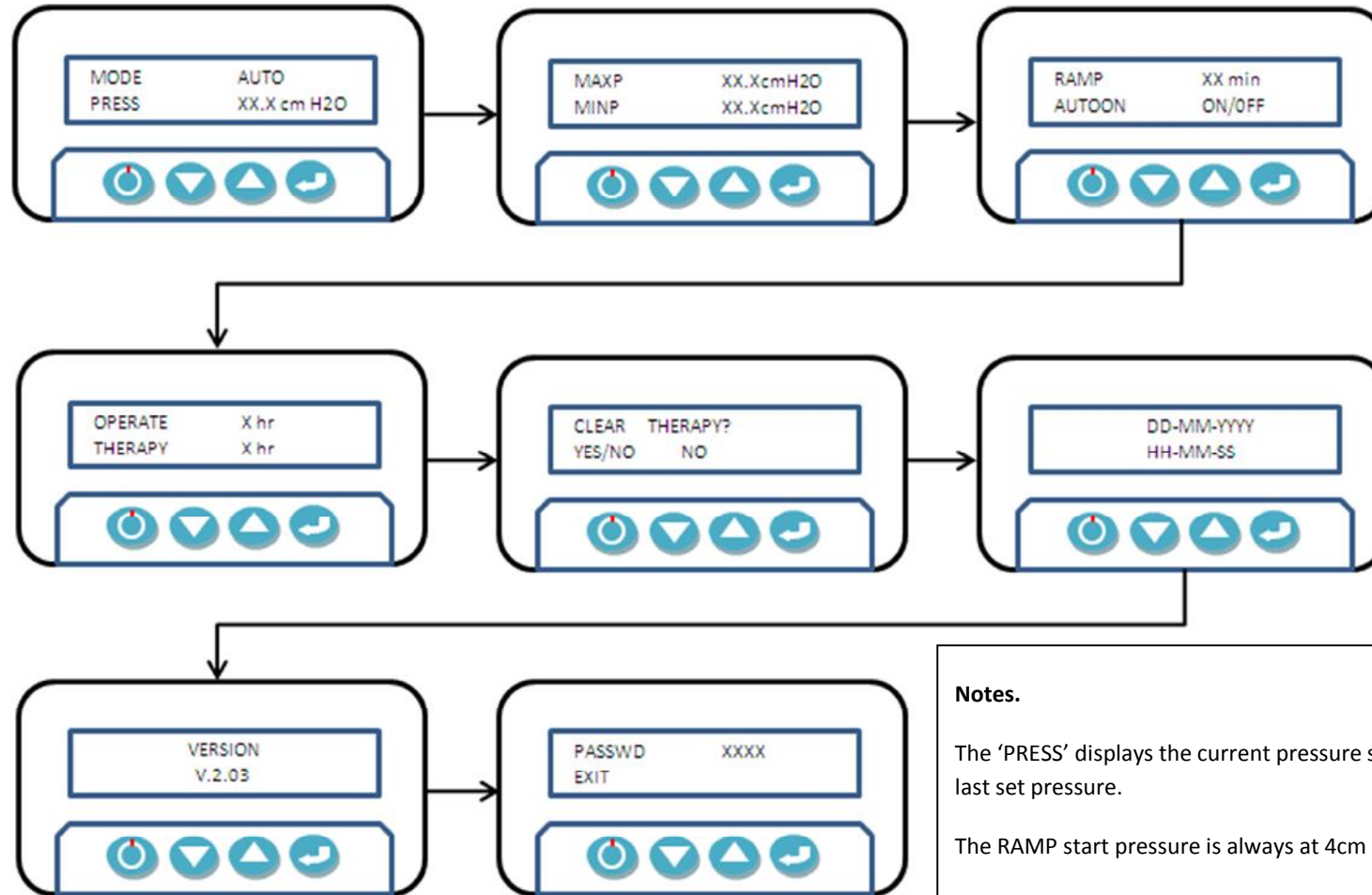

Notes.

The 'PRESS' displays the current pressure setting. The default value is the last set pressure.

The RAMP start pressure is always at 4cm H2O.

A password is required to clear the Therapy Time on page 5. To set the password (page 8) key in 4 digits by using the input keys. Once the password is accepted it will jump to page 5. To exit password page select EXIT

FUNCTIONS OF THE DEVICE

AUTOMATIC MODE

If the device is in Automatic mode the first breath will activate the device when the patient is wearing the mask.

- The device will switch to standby mode if:
 - The mask is off for 3 seconds or more,
 - The patient hose is disconnected, or
 - The humidifier is switched off.

MANUAL MODE

If the device is in Manual mode then use the ON/OFF key to start the device.

RAMP FUNCTION

When this function is selected the device will start delivering the minimum air pressure first before increasing the pressure steadily to the set pressure within the set time. This function is to allow the patient to fall asleep more comfortably. This soft start function is particularly helpful for patients who are not accustomed to continuous positive airway pressure therapy. The pressure delay time range is between 0 - 60 minutes with pressure steps every minute.

When using Ramp function pressing the On/Off key will activate the Ramp. If the On/Off key is pressed again the Ramp function will be skipped and the air pressure will rise to the set pressure.

ALARMS

POWER FAILURE



WARNING! During use if a power failure occurs patients may inhale expired air.

- In case of a power failure or if the power cord is disconnected the alarm will sound to inform the patient that they should remove the mask.
- The alarm can be switched off by pressing the on/off key or will switch off automatically if power resumes.

CHECKING THE POWER FAILURE ALARM

Switch the device on and keep running for at least 10 seconds. If the power cord is unplugged or the power is switched off at the socket the alarm should sound. Check whether the alarm lasts long enough (around 30sec). When the device is switched on the alarm should stop automatically. Please check the alarm at least once a month.

LEAKAGE



WARNING! To minimize leakage ensure that the headgear is adjusted and fits appropriately

- When the device detects that a patient's mask has been taken off, or if there is an air leak, the motor will run at a lower speed automatically and the pressure will reduce to below the set pressure.
- When the air leakage stops the device will work normally again and return to the set pressure.

CLEANING AND MAINTENANCE

CLEANING THE CURASA AUTO CPAP



WARNING! To avoid electrical shock unplug the Curasa AUTO CPAP power cord before cleaning the device

WARNING! Do not immerse the device in liquid or allow any liquid to enter the enclosure, inlet filter, or any other openings

1. To clean the exterior of the device use a dampened cloth and a mild detergent. Allow the device to dry completely before plugging in the power cord.
2. The mask and tubing should be cleaned daily. For details on cleaning your mask and accessories refer to the cleaning instructions packaged with the accessories.

CHANGING THE CURASA AUTO CPAP CLOCK BATTERY

A rechargeable Lithium Button Battery is used for the clock inside the device. There is a danger of explosion and fire if the battery is incorrectly replaced. Replace only with the same type RTC battery. Model: MC621, 3.0 V, 3 mAh.

CLEANING THE HUMIDIFIER

1. Disconnect the patient hose from the humidifier and remove the upper cap of the humidifier.
2. Empty the water out of the humidifier before cleaning it with a moistened cloth with a mild detergent or soapy water.
3. Never submerge the humidifier in water!

HUMIDIFIER FUSE

The specification of the fuse for the heater in humidifier is 108°C 250V 10A

CHANGING FILTER

The fine filter is in the filter cassette at the back of the device. Take it out and change it with a new one every week. Never use the device without a filter.

Dirty inlet filters may cause high operating temperatures that may affect device performance. Regularly examine the inlet filters for cleanliness. If there is a lot of dust or smoke in the environment change the filter more frequently.

TROUBLESHOOTING

- Different problems that may be encountered, their causes and solutions are detailed below.
- If your dealer cannot resolve the problems, please consult your physician or contact our service center.

Problem	Cause	Solution
Dryness and irritation of nose and throat	<ul style="list-style-type: none"> • Dry air 	<ul style="list-style-type: none"> • Use a humidifier or heated humidifier
Cold nose	<ul style="list-style-type: none"> • Low room temperature 	<ul style="list-style-type: none"> • Increase room temperature
Dryness in mouth and pharynx	<ul style="list-style-type: none"> • Breathing through mouth 	<ul style="list-style-type: none"> • Use chin strap or full face mask • Low therapeutic pressure (ask your physician)
Irritated or dry eyes	<ul style="list-style-type: none"> • Leakage between mask and skin 	<ul style="list-style-type: none"> • Adjust the mask's position and headgear. • If the mask is worn out, change it. Try another type of mask.
Redness or inflammation of skin under the mask	<ul style="list-style-type: none"> • Headgear is too tight • Wrong mask size • Allergic reaction 	<ul style="list-style-type: none"> • Loose the headgear • Ask your physician • Ask your physician
Water in the mask	<ul style="list-style-type: none"> • When the room temperature is low and the humidifier is on, it may cause water to condense. 	<ul style="list-style-type: none"> • Lower the humidifier's heating temperature or increase the room temperature. Wrap the patient hose in a towel or a soft cloth to keep warm.

Problem	Cause	Solution
Low output pressure or big pressure fluctuation	<ul style="list-style-type: none"> • Water getting in the pressure sampling tube or the pressure tube blocked. • The pressure tube may not be connected with the device. 	<ul style="list-style-type: none"> • Dry thoroughly or clean the pressure tube. • Connect the pressure tube with the device correctly.
Pain in nose, sinuses or ears.	<ul style="list-style-type: none"> • inflammation 	<ul style="list-style-type: none"> • Stop therapy and see your physician immediately.
Discomfort due to high pressure.	<ul style="list-style-type: none"> • When pressure is over 13cmH₂O(~1.3kPa), some patients will feel unpleasant. But this pressure may be needed for effective therapy. 	<ul style="list-style-type: none"> • You may take up to 4 weeks to be accustomed to higher pressures. When using the device, breathe through nose with mouth closed and keep calm. If you continue to experience discomfort consult your physician.
Symptoms of sleep apnea syndrome appears again. (like day time sleepiness)	<ul style="list-style-type: none"> • When your weight is increased, your nose is blocked or you drink etc, you need higher pressures. 	<ul style="list-style-type: none"> • Consult your physician.
Air is too warm	<ul style="list-style-type: none"> • Dirty filter • Air inlet blocked • The device is too close to wall, curtains or other objects, which hinders air circulation 	<ul style="list-style-type: none"> • Change filter • Check air inlet • Take away the device to keep it over 20cm from wall, curtains or other objects
No air flow	<ul style="list-style-type: none"> • Defective device • Water in the pressure tube 	<ul style="list-style-type: none"> • Contact our service center • Dry the pressure tube thoroughly

Problem	Cause	Solution
Low air flow	<ul style="list-style-type: none"> • Ramp function is active • Air inlet blocked 	<ul style="list-style-type: none"> • Decrease soft start time • Check air inlet
Motor always operates at maximum speed	<ul style="list-style-type: none"> • The pressure tube is not connected or it is blocked • Leakage in the device 	<ul style="list-style-type: none"> • Check the pressure tube • Contact our service center
When turned on, the device doesn't work	<ul style="list-style-type: none"> • The device is in automatic operation (AUTO ON) • Power is not plugged in • No electric supply • Fuse is blown (Note: before checking, unplug power cable!) 	<ul style="list-style-type: none"> • Set the device to manual operation (AUTO OFF) • Check whether power cable is connected with the device • Check main electricity supply, • Change fuse • Contact our service center
Motor works normally but the output pressure is lower than the set pressure	<ul style="list-style-type: none"> • Patient hose or pressure tube is not correctly connected with the device • Air leakage through mask or patient tube • Defect device 	<ul style="list-style-type: none"> • Check whether connection is correct and firm • Contact our service center
Only low output pressure	<ul style="list-style-type: none"> • Dirty filter or air outlet blocked • Therapeutic pressure readjusted • Soft start function active 	<ul style="list-style-type: none"> • Change filter, check air outlet • Consult your physician • If necessary, cancel soft start function or set soft start function time again
Too noisy	<ul style="list-style-type: none"> • Patient hose is not connected or connected incorrectly • Leakage through mask or patient hose • Not air tight between humidifier and device 	<ul style="list-style-type: none"> • Check connection • Check patient hose • Check humidifier and device
Power failure alarm invalid	<ul style="list-style-type: none"> • The device not used for long time (at least three months) 	<ul style="list-style-type: none"> • Put the device on stand-by mode for 12 hours.

SERVICE

- Service of the Curasa AUTO CPAP should only be performed by persons authorized by the company.
- To increase the device’s life, the user must read the Curasa AUTO CPAP sleep apnea breathing therapy device’s safety instructions and cleaning instructions.

SPECIFICATIONS

Curasa AUTO CPAP	
Pressure range	4cm H ₂ O (~0.4kPa) -20 cm H ₂ O (~2.0kPa)
Pressure variance	±0.4 cm H ₂ O (~0.04kPa)
Ramp time	0-60min. adjustable 1min./step
Noise: (10 cm H₂O/~1.0kPa)	<29dB (A)
Dimensions	170 mm L* 117 mmW * 93 mmH
Weight	1.4Kg (1.0Kg without humidifier)
Water temperature	44°C Maximum
DC Voltage	24VDC
DC Current	2.5A Maximum
Protection again electric shock	Class II
Degree of protection against electric shock	Type B Applied Part
Degree of protection against harmful ingress of water	Ordinary Equipment, IPX0
Electromagnetic Compatibility	Curasa AUTO CPAP sleep apnea breathing therapy device meets the requirements of EN 60601-1-2.
Fuses	There are no user-replaceable fuses.

AC/DC adapter	
Model	SNP- A069
Output	+24V --- , 2.5A
Input	100-240V \sim , 50/60Hz, 2-1A

Operation	
Temperature	+5°C \sim +35°C
Relative humidity	10% \sim 93%(non-condensing)
Atmosphere pressure	700hPa \sim 1060hPa

Transport or storage	
Temperature	-20°C \sim +55°C
Relative humidity	10% \sim 93%(non-condensing)
Atmosphere pressure	500hPa \sim 1060hPa

DISPOSAL



This device, its accessories and its packaging have to be disposed correctly at the end of the usage. Please follow Local Laws and Ordinances for disposal.

ELECTRIC MAGNETIC INFORMATION

GUIDANCE AND MANUFACTURERS DECLARATION OF ELECTROMAGNETIC IMMUNITY FOR EQUIPMENT AND SYSTEMS THAT ARE NOT LIFE SUPPORTING

Attention! Please use Curasa Auto CPAP Sleep apnea breathing therapy device according to electric magnetic information in list.

The Curasa Auto CPAPs intended for use in the electromagnetic environment specified below. The user of the Curasa Auto CPAP should ensure that it is used in such an environment.

Emission test	Compliance	Electromagnetic environment – guidance
RF emissions CISPR 11	Group 1	The Curasa Auto CPAP uses RF energy only for its internal function. Therefore, its RF emissions are very low and are not likely to cause any interference in nearby electronic equipment. The Curasa Auto CPAP is suitable for use in all establishments, including domestic establishments and those directly connected to the public low-voltage power supply network that supplies buildings used for domestic purposes.
RF emission CISPR 11	Class B	
Harmonic emissions IEC 61000-3-2	Class A	
Voltage fluctuations/ flicker emissions IEC 61000-3-3	Complies	

Immunity test	IEC 60601 test level	Compliance level	Electromagnetic environment – guidance
Electrostatic discharge (ESD) IEC 61000-4-2	±6 kV contact ±4 kV air ±8 kV air	±6 kV contact ±4 kV air	Floors should be wood, concrete or ceramic tile. If floor are covered with synthetic material, the relative humidity should be at least 30%.
Electrical fast transient/burst IEC 61000-4-4	±2 kV for power supply lines	±2kV for power supply lines	Mains power quality should be that of a typical commercial or hospital environment.
Surge IEC 61000-4-5	±1 kV differential mode	±1 kV differential mode	Mains power quality should be that of a typical commercial or hospital environment.
Voltage dips, short interruptions and voltage variations on power supply input lines IEC 61000-4-11	<5% UT (>95% dip in UT) for 0.5 cycle 40% UT (60% dip in UT) for 5 cycles 70% UT (30% dip in UT) for 25 cycles <5% UT (>95% dip in UT) for 5 sec	<5% UT (>95% dip in UT) for 0.5 cycle 40% UT (60% dip in UT) for 5 cycles 70% UT (30% dip in UT) for 25 cycles <5% UT (>95% dip in UT) for 5 sec	Mains power quality should be that of a typical commercial or hospital environment. If the user of the Curasa Auto CPAP requires continued operation during power mains interruptions, it is recommended that the Curasa Auto CPAP be powered from an uninterruptible power supply or a battery.
Power frequency (50/60Hz) Magnetic field IEC-61000-4-8	3 A/m	3 A/m	Power frequency magnetic fields should be at normal levels typical of a location in a commercial or hospital environment.
NOTE: UT is the A/C mains voltage prior to application of the test level.			

Immunity test	IEC 60601 test level	Compliance level	Electromagnetic environment – guidance
<p>Conducted RF IEC 61000-4-6</p> <p>Radiated RF IEC 61000-4-3</p>	<p>3 Vrms 150 kHz to 80 MHz</p> <p>3 V/m 80 MHz to 2.5 GHz</p>	<p>3 Vrms</p> <p>3 V/m</p>	<p>Portable and mobile RF communications equipment including cables should not be used close to any part of the Curasa Auto CPAP other than the recommended separation distance calculated from the equation applicable to the frequency of the transmitter.</p> <p>Recommended separation distance</p> $d = \left[\frac{3.5}{V_1} \right] \sqrt{P}$ $d = \left[\frac{3.5}{E_1} \right] \sqrt{P} \quad 80 \text{ MHz to } 800 \text{ MHz}$ $d = \left[\frac{7}{E_1} \right] \sqrt{P} \quad 800 \text{ MHz to } 2.5 \text{ GHz}$ <p>Where P is the maximum output power rating of the transmitter in watts (W) according to the transmitter manufacturer and d is the recommended separation distance in metres (m). Field strengths from fixed RF transmitters, as determined by an electromagnetic site survey, a should be less than the compliance level in each frequency range. b Interference may occur in the vicinity of equipment marked with the following symbol:</p> 
<p>NOTE 1: At 80 MHz and 800 MHz, the higher frequency range applies.</p> <p>NOTE 2: These guidelines may not apply in all situations. Electromagnetic propagation is affected by absorption and reflection from structures, objects and people.</p>			<p>Field strengths from fixed transmitters, such as base stations for radio (cellular/cordless) telephones and land mobile radios, amateur radio, AM and FM radio broadcast and TV broadcast cannot be predicted theoretically with accuracy. To assess the electromagnetic environment due to fixed RF transmitters, an electromagnetic site survey should be considered. If the measured field strength in the location where the Curasa Auto CPAP is used exceeds the applicable RF compliance level above, the Curasa Auto CPAP should be observed to verify normal operation. If abnormal performance is observed additional measures may be necessary, such as, re-adjusting or relocating the Floton Auto CPAP.</p> <p>b Over the frequency range 150 kHz to 80 MHz, field strengths should be less than 3 V/m.</p>

RECOMMENDED SEPARATION DISTANCES BETWEEN PORTABLE AND MOBILE RF COMMUNICATIONS EQUIPMENT AND THE FLOTON AUTO CPAP

The Curasa Auto CPAPs intended for use in an electromagnetic environment in which radiated RF disturbances are controlled. The customer or the user of the Curasa Auto CPAP can help prevent electromagnetic interference by maintaining a minimum distance between portable and mobile RF communications equipment (transmitters) and the Curasa Auto CPAPs recommended below, according to the maximum output power of the communications equipment

Rated maximum output power of transmitter (W)	Separation distance according to the frequency of transmitter (m)		
	150 kHz to 80 MHz $d = \left[\frac{3.5}{V_1} \right] \sqrt{P}$	80 MHz to 800 MHz $d = \left[\frac{3.5}{E_1} \right] \sqrt{P}$	800 MHz to 2.5 GHz $d = \left[\frac{7}{E_1} \right] \sqrt{P}$
0.01	0.12	0.12	0.23
0.1	0.39	0.37	0.74
1	1.17	1.17	2.33
10	3.69	3.69	7.38
100	11.67	11.67	23.33

For transmitters rated at a maximum output power not listed above, the recommended separation distance d in metres (m) can be estimated using the equation applicable to the frequency of the transmitter, where P is the maximum output power rating of the transmitter in watts (W) according to the transmitter manufacturer.

NOTE 1: At 80 MHz and 800 MHz, the separation distance for the higher frequency range applies.

NOTE 2: These guidelines may not apply in all situations. Electromagnetic propagation is affected by absorption and reflection from structures, objects and people.

CONTACT DETAILS**Curative Medical Devices GmbH**

Manufacturer address: Blasewitzer Str. 41, 01307 Dresden, Germany

Tel: +49-351-4504500

Fax: +49-351-4504511

info@curative.net